



Inverted Research Microscope
ECLIPSE

Ti

At the Center of Your Research Discoveries

The Essence of Cutting-edge Microscopy Research

Microscopes are critical tools for cutting-edge research in biology, medical and pharmaceutical sciences. To satisfy the demands of today's high-end research, Nikon has developed the new Ti series of microscopes. Combined with NIS-Elements imaging software, the Ti supports diverse image acquisition and analysis methods such as multi-dimensional time-lapse imaging to acquire temporal, spatial and spectral information of fast, dynamic live cell processes. Intelligently designed automation and further expansion of Nikon's powerful modular approach make the Ti ideal for applications such as confocal, FRET, High Content Analysis (HCS), and photobleaching/photo activation to study interaction of fluorescence protein molecules in living cells and tissues. Nikon's exclusive Perfect Focus System (PFS) is now incorporated into the nosepiece unit and allows for the simultaneous use of two separate levels for additional illuminators or detectors. The newly developed "full intensity" phase contrast unit enables acquisition of incredible phase contrast images without the use of light-attenuating phase contrast objectives.

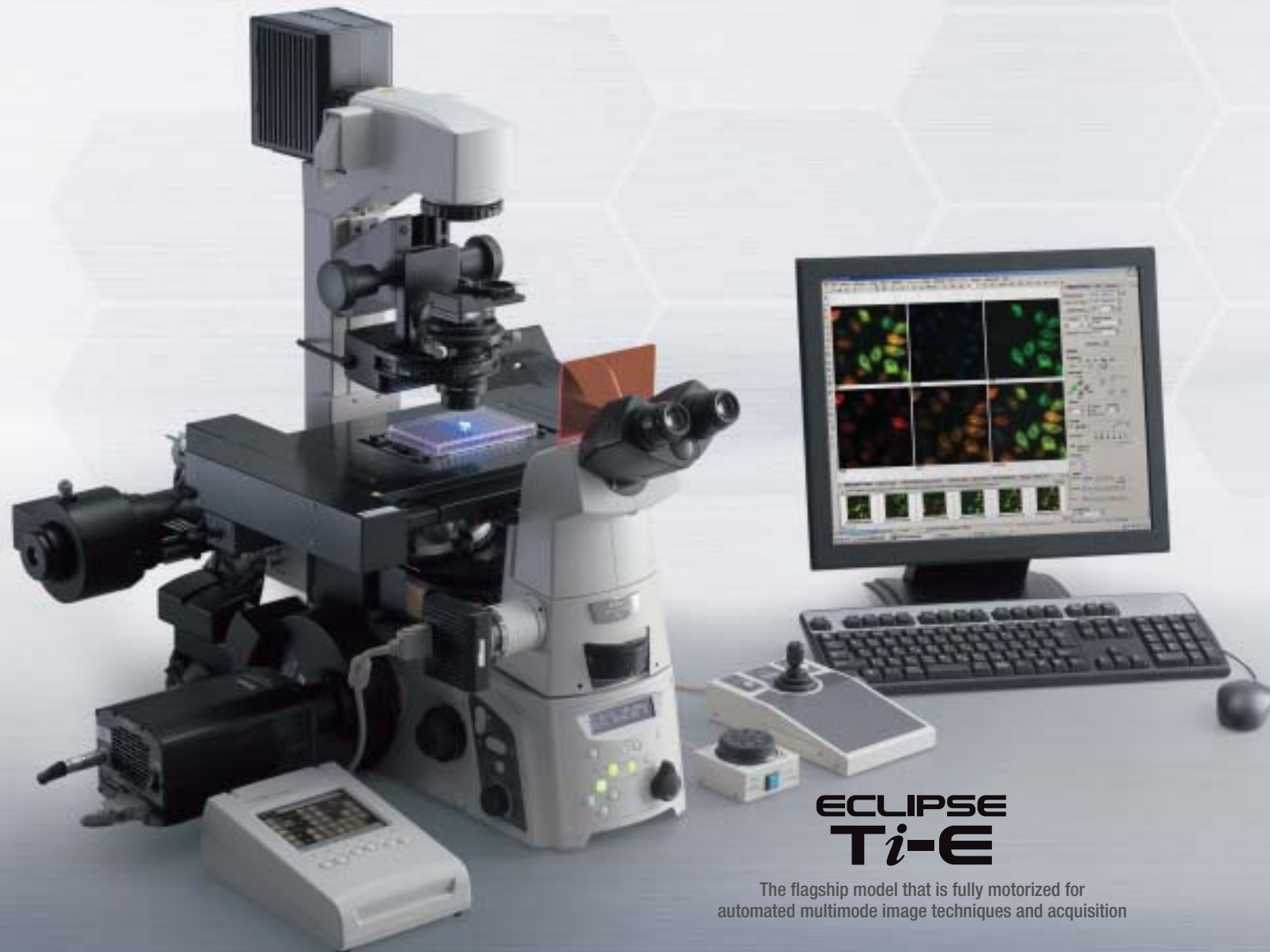

**ECLIPSE
Ti-E**

The flagship model that is fully motorized for automated multimode image techniques and acquisition

● Advanced functions of Ti-E dramatically expand research imaging possibilities

Fast and Automated

High-speed motorized components allow fast, coordinated and seamless image acquisition [P4]

Screening

Multimode scanning of well plate at an unprecedented speed [P5]

Time-lapse Imaging

Built-in Perfect Focus System (PFS) for automatic focus correction [P6]

High-quality Phase Contrast Observation

Newly developed "full intensity" optical components enable phase contrast with high NA non-phase-contrast objectives [P8]

Multiple Cameras

Image acquisition and analysis with multiple side ports and back port cameras [P9]

Motorized Laser TIRF (Total Internal Reflection Fluorescence) Observation

Alternate time-lapse observation between widefield fluorescence and TIRF (NA 1.49) images by fast illumination switching and motorized control of laser incident angle [P10]

Photo Activation

The photo activation unit allows cell marking and dynamic analysis using photoactivatable and photoswitchable proteins such as PA-GFP and Kaede [P11]

Confocal Imaging

Seamless integration with confocal microscope systems for high-performance spectral confocal imaging [P19]



**ECLIPSE
Ti-U**

The universal model that comes standard with four output ports and potential for motorized components



**ECLIPSE
Ti-S**

The basic model that can be dedicated to specific tasks, built with two output imaging ports



Ti: Stress-Free Operation

High-speed Motorized Control and Acquisition

The synchronized control of many motorized components such as the nosepiece, fluorescence filters, shutters, condenser turret and stage, allows researchers to use the microscope for a wide range of automated multi-dimensional experiments. Faster device movement and image acquisition decrease overall light exposure and subsequent photo-toxicity, leading to more meaningful data.



Enhanced speed of individual motorized components

Operation and/or changeover speed of objectives, filter cubes, XY stage, excitation/barrier filters has been greatly enhanced, realizing stress-free operational environment that enables researchers to focus on observations and image capture routines. The newly developed controller that memorizes and reproduces observation conditions and the joystick that enables stage control at will make the microscope feel like an extension of your eyes and hands.

High-speed XY stage movement



Nikon-exclusive high-speed encoded stage

High-speed Piezo Z stage movement



Nikon-specified Piezo Z specimen stage

High-speed epi-fl filter changeover



Nikon filter dichroic cube turret

Newly developed digital Controller Hub significantly increases motorized accessory speed by reducing the communication overhead time between components, boosting total operation speed.

PC control and automation of the Ti's motorized components are optimized to reduce the respective communication time between action commands and movements producing high-speed total control. By adding firmware intelligence to the microscope, total operation time of the motorized components is reduced. For example, the total time for continuous image acquisition in three modes (two-channel fluorescence and phase contrast) with illumination shutter control is greatly reduced enhancing cell viability.

Control process

Conventional model

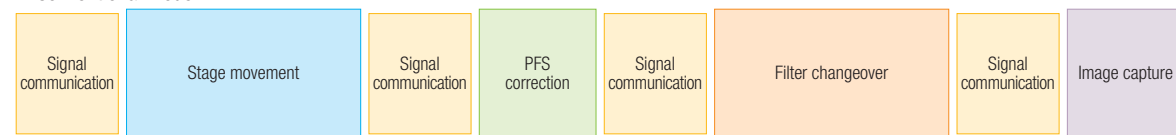

Ti-E

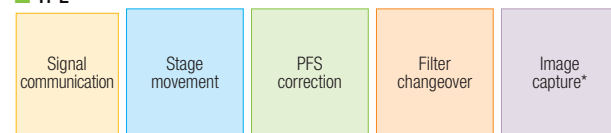

*When used in conjunction with Nikon's DS-Qi1 or Andor iXon, the experimental protocol is loaded and run from internal memory, eliminating communication overhead between the PC and microscope and significantly reducing acquisition time. No critical events are lost due to time delays.

Remarkably Fast Image Acquisition!

Screening image capture of 96 wells in three modes (two-channel fluorescence and phase contrast) is possible at a speed of more than twice that of conventional models.

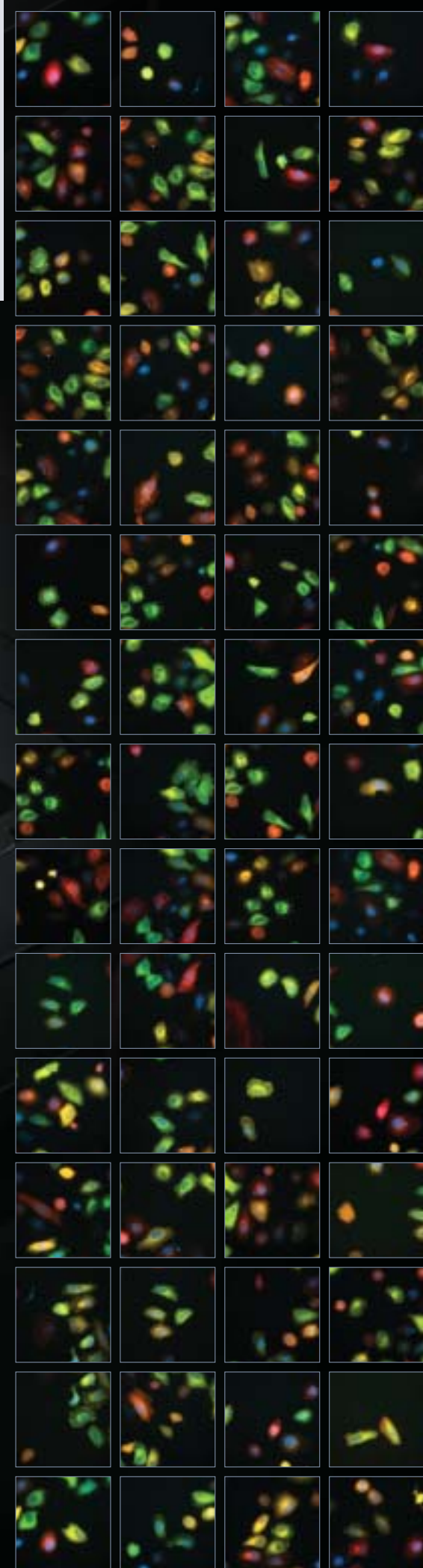
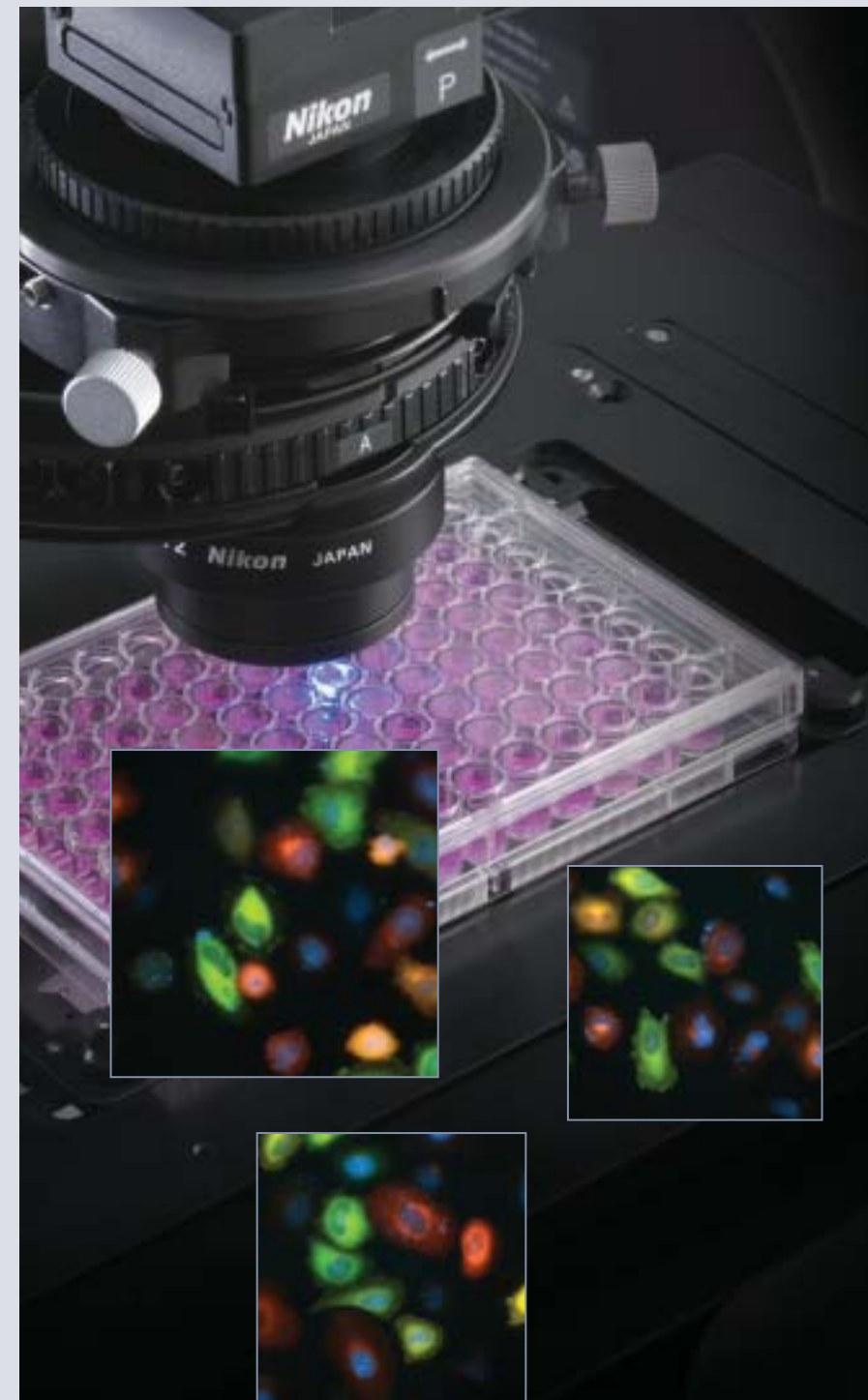

Multipoint snapshots of HeLa cells transiently expressing Venus-tubulin and mCherry-actin and stained with Hoechst33342 and DiD. (All in pseudo-color)

Photos courtesy of: Kenta Saito and Takeharu Nagai, Research Institute for Electronic Science, Hokkaido University

PFS and NIS-Elements Realize Stable and Reliable Imaging

Nikon's exclusive and integrated Perfect Focus System (PFS) eliminates focus drift

Focus drift is one of the biggest obstacles in time-lapse observation. Nikon's PFS design corrects focus drift during long-term observation and when reagents are added. Even with high magnification, high NA objectives and techniques like TIRF, your images are always in sharp focus. Additionally, incorporating PFS in the nosepiece unit saves space and does not limit the use of the Ti expanded infinity space stratum structure (see page 9).



Real-time focus correction

The PFS employs high-performance optical offset, making real-time correction in the desired Z-plane possible. The state of the PFS is prominently displayed on the front of the microscope. Moreover, when the PFS is not in use, the optical component of the PFS can be simply retracted from the optical path.

Concept of the Perfect Focus System

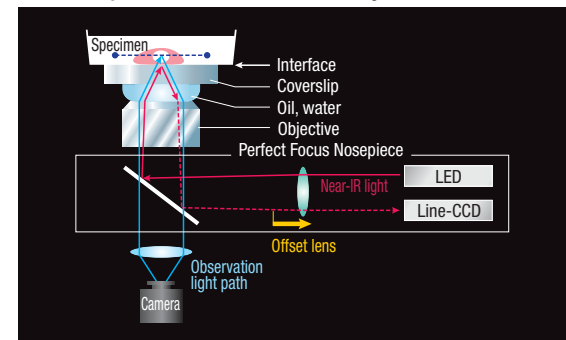

The diagram shows the case when an immersion type objective is used. A dry type objective is also available.

Correction to focus drift when reagents are added

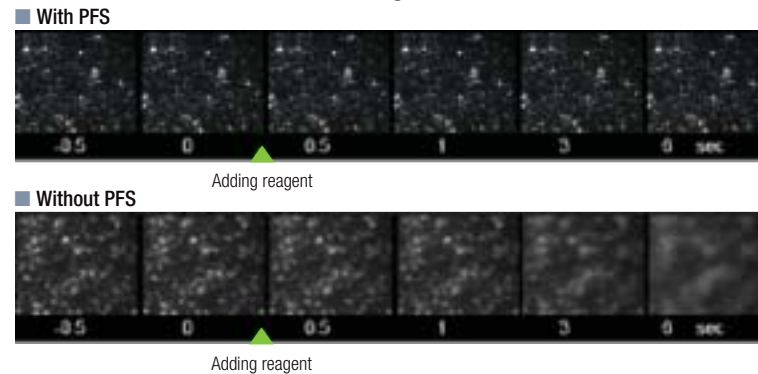

Compatible with diverse fluorescence dyes with improved performance in broader wavelength range

By now employing 870nm wavelength for the coverglass interface detection, near-infrared fluorescence dyes including Cy5.5 can be used. As the optical characteristics from ultraviolet to infrared range are also improved, the number of usable objectives is increased, realizing stable focus in applications requiring a wide range of wavelengths from Ca²⁺ concentration measurement in the UV to laser tweezers in the IR.

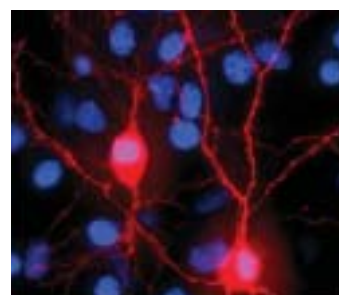

Live imaging of primary rat cortical neurons stained with Hoechst33342 and DiI
Photo courtesy of: Ippei Kotera, Shinya Hosaka and Takeharu Nagai, Research Institute for Electronic Science, Hokkaido University

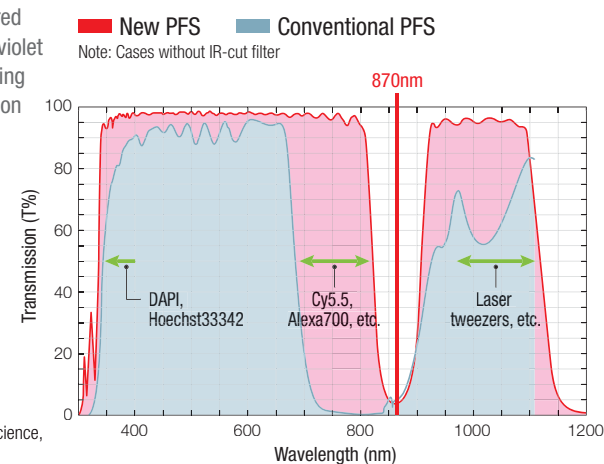

Comprehensive Imaging Software NIS-Elements Provides Secure System Control



Nikon's original imaging software NIS-Elements provides an integrated control of the microscope, cameras, components and peripherals and allows the programming of automated imaging sequences. The intuitive GUI makes setting of the experiment parameters easy and reproducible. NIS-Elements offers many tools and controls to facilitate flexible and reliable data acquisition, paired with a diverse suite of analysis tools for measurement, documentation and databasing.

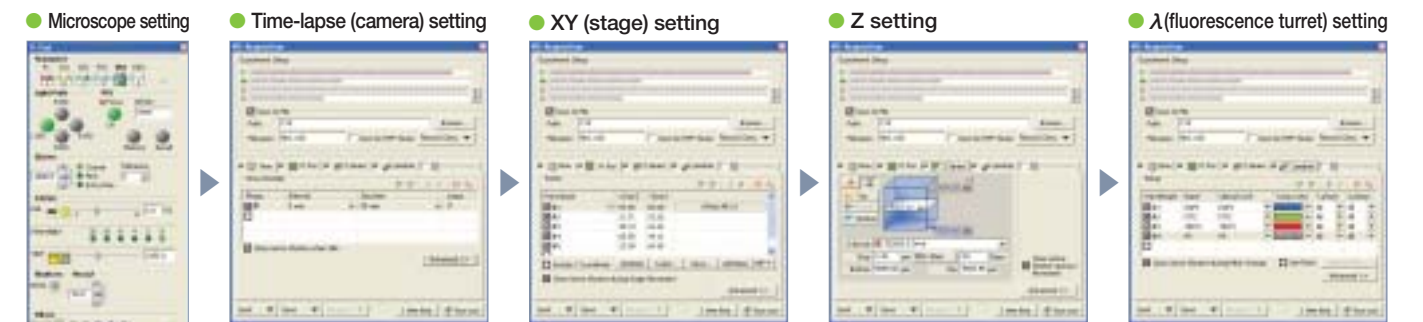

Intuitive GUI and efficient workflow of NIS-Elements make 6D (X, Y, Z, t (time), Lambda (wavelength), multipoint) image acquisition that requires complex settings easy to perform. Simply by choosing the necessary parameters for each dimension, images are automatically captured and a multi-dimensional ND2 file is generated, which can be seamlessly viewed, analyzed, and exported. Converting the format of the captured multi-dimensional image to standard formats is also easy to accomplish.

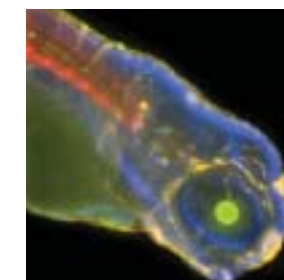

Zebrafish larva transgenically expressing lens specific GFP and stained with Hoechst33342, acetylated tubulin-Alexa555 and phalloidin-Alexa647

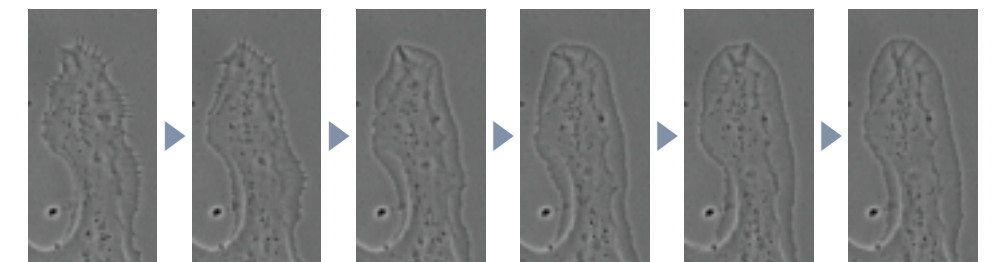

NG108 cell
Photos courtesy of: Satoe Ebihara, Kaoru Katoh, The National Institute of Advanced Industrial Science and Technology (AIST)

Photo courtesy of: Kazuki Horikawa and Takeharu Nagai, Research Institute for Electronic Science, Hokkaido University

NIS-Elements 6D time-lapse imaging system

By combining the Nikon motorized stage, motorized filter turret and "smart" specified shutters, acquisition of multipoint, multi-channel time-lapse images and Z-axis information of each of these points is possible.

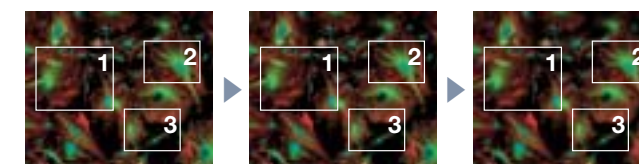

Ti: Revolutionary Phase Contrast System

High-quality Phase Contrast Images with High NA Lens, as well as Bright Fluorescence Images

Nikon's world-leading optical designers have developed the unique "full intensity" external phase contrast unit. With this revolutionary system, a phase ring is incorporated in the microscope body instead of the objective lens, allowing the use of specialized objectives without phase rings and acquisition of high-quality images with high NA objectives. Moreover, using the objectives without a phase ring enables capturing of "full intensity" bright fluorescence images.



Ti: Maximum Flexibility & Expandability

Multiport and Stratum Structure Support Advanced Research

Multiple image port design with left, right, and bottom* ports for optical output enables a camera or detector to be attached to each port. Furthermore, the expanded space stratum structure enables addition of an optional back port. These features allow simultaneous image capture with multiple cameras using two-tier dichroic fluorescence filter turrets.

*Available with Ti-E/B and Ti-U/B models with bottom port

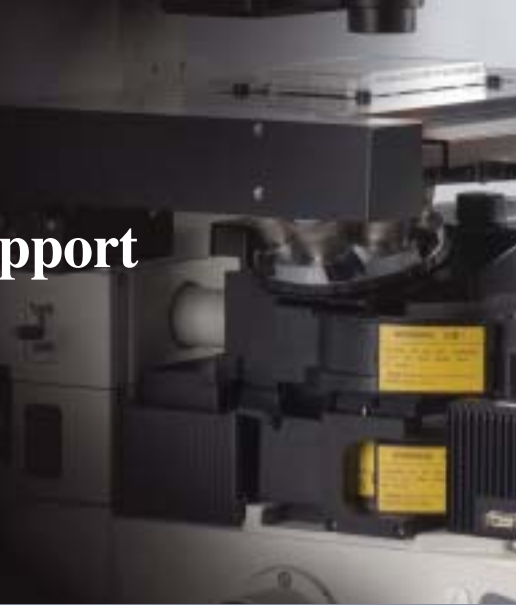

Phase ring is incorporated in the microscope body

Incorporating a phase ring—that was normally positioned within the phase contrast objective lens—into the external phase contrast unit optically allows use of specified high NA objectives to produce high-resolution phase contrast images. Four types of phase contrast rings are available according to the objectives used. (common for Ti-E/U/S)



Changing the conventional concept of phase contrast

Unprecedented high resolution

Nikon's high-performance objective lenses, including the 60x and 100x TIRF objectives with the world's highest numerical aperture of 1.49 incorporating spherical aberration correction collars, deliver high-resolution phase contrast images that can not be captured with any standard phase contrast objective.

Bright fluorescence image using same objective

Because there is no light loss due to a phase ring, bright "full intensity" fluorescence, confocal and TIRF images can be captured using the same objective as well as providing phase contrast observation.



NG108 cell: Growth cone stained with EGFP-fascin
Photos courtesy of: Satoe Ebiyama, Kaoru Katoh, The National Institute of Advanced Industrial Science and Technology (AIST)

Use of laser tweezers without changing lens

Because an objective without a phase ring can be used for phase contrast observation, use of laser tweezers is possible without changing the objective lens.

Phase contrast observation with water immersion objective

It is now possible to use a water immersion objective for phase contrast observation. Clear, high-resolution—refractive index matched—phase contrast images with minimal aberration of deep specimen areas can be captured.

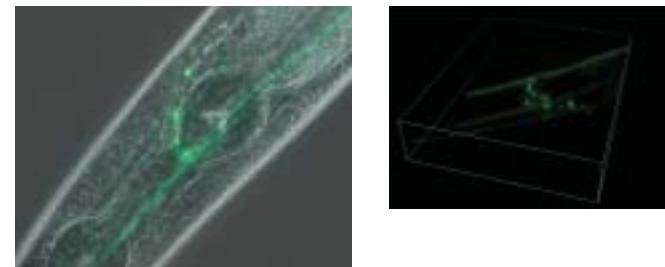

C. elegans: Touch neurons stained with EGFP
Photos courtesy of: Motomichi Doi and Kaoru Katoh, The National Institute of Advanced Industrial Science and Technology (AIST)

High resolution effective for image analysis

Because phase contrast observation is also possible with the same objective used for TIRF observation as well as DIC observation, phase contrast images with less oblique background shading than that of DIC observation are captured, allowing high-precision data processing and image analysis such as cell contour definition of TIRF image specimen.

Back port enables multiple camera imaging

Use of an optional back port expands the image capture capability. Used in combination with the side port it allows simultaneous image acquisition for two wavelengths with two cameras. For example, when observing interaction between fluorescence proteins with FRET (Förster Resonance Energy Transfer) and intensity difference between CFP and YFP is great, individual camera sensitivity adjustment allows comparison of high S/N ratio images.

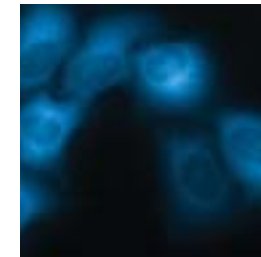

ECFP image from YC3.60

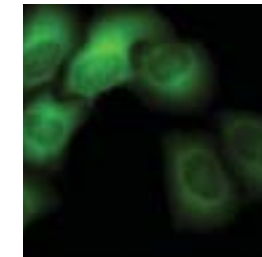

cp173Venus image from YC3.60

Photos courtesy of: Kenta Saito and Takeharu Nagai, Research Institute for Electronic Science, Hokkaido University



Back port can be attached as an option.

Stratum structure enables flexible extendibility

The Ti employs the stratum structure that takes advantage of infinity optics. In addition, the PFS is incorporated in the nosepiece unit, allowing two optical component levels in addition to the PFS to be attached by using the "stage up position set." Simultaneous mounting of laser tweezers and photo activation unit as well as multiple stacked epi-fluorescence filter turrets is possible. Each of the tiered motorized filter cube turrets can be controlled individually.



Example: In addition to the PFS, a photo activation module (upper tier) and a back port (lower tier) are mounted.

Advanced Fluorescence Illumination Functions Respond to Leading Bio-imaging from Live Cell to Single Molecule

The Ti series provides a diverse choice of fluorescence illuminators to support cutting-edge research of cell biology, molecular biology and biophysics using the new imaging and photo activation technologies.

Laser TIRF (Motorized/Manual)

For observation of cell membrane dynamics and single molecules



Motorized TIRF illumination unit



This unit allows total internal reflection fluorescence observation of specimens such as cell focal adhesions or single molecules in-vitro using laser illumination. When used with a high-sensitivity camera, images with extraordinarily high S/N ratios that allow observation of single molecules can be captured.

The newly developed motorized laser TIRF illumination unit allows laser incident angle adjustment, shutter control and switchover to widefield fluorescence excitation using the control pad or NIS-Elements software. Laser incident angles can be saved with a single touch of the control pad button and can be easily retrieved, enabling alternate time-lapse recording between fluorescence and multi-wavelength TIRF images.



Remote controller

Principle of TIRF (Total Internal Reflection Fluorescence)

When light is incident to the coverslip at an angle greater than the critical angle (θ_c) for Total Internal Reflection, the light no longer propagates through the specimen, but sets up an evanescent field at the coverslip/specimen interface that can excite fluorescence in the specimen in an optical section less than 100nm. By exciting such a thin section within the specimen, extremely high S/N data can be acquired.

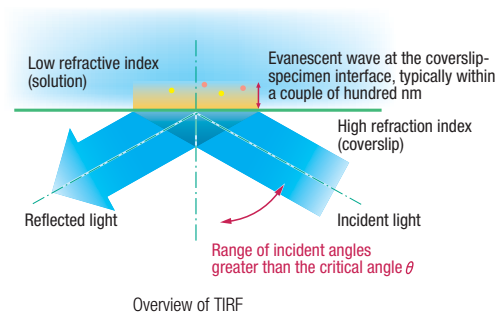

Overview of TIRF

TIRF objectives feature a high NA of 1.49—very close to the theoretical limit for standard oil immersion—and can capture even single-molecule images.



CFI Apochromat TIRF 60x Oil (left)
CFI Apochromat TIRF 100x Oil (right)

Time-lapse imaging by switching TIRF and epi-fluorescence observation

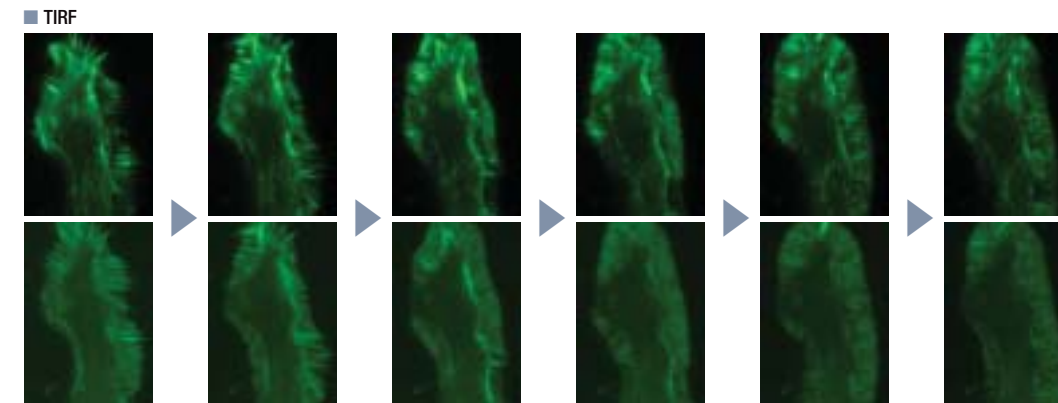

Epi-fl

NG108 cell: Growth cone stained with EGFP-fascin

Photos courtesy of: Satoe Ebihara, Kaoru Katoh, The National Institute of Advanced Industrial Science and Technology (AIST)

Photo activation

For observation of photo-activated and photo-convertible fluorescent protein



Photo activation illuminator unit

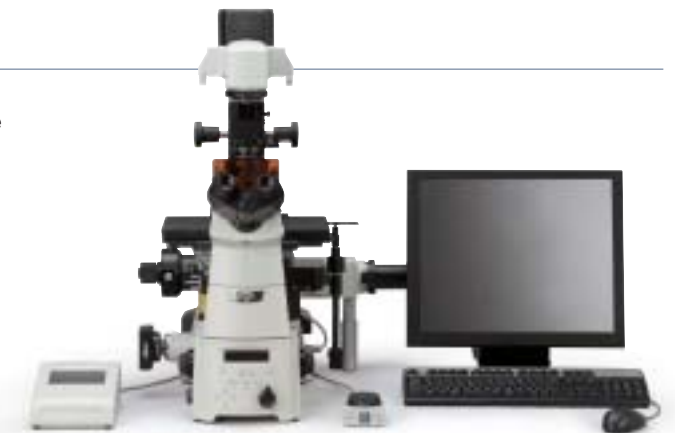

When fluorescence proteins such as Kaede and PA-GFP are exposed to 405nm illumination, fluorescence characteristics change. For example, Kaede changes fluorescence colors from green to red, and PA-GFP increases fluorescence intensity 100 times. Kaede and PA-GFP are used, respectively, for selectively highlighting cells and proteins of interest within live specimens and studying their dynamics. The photo activation illuminator utilizes lasers ranging from 405nm to 647nm to produce target spots of varying diameters, allowing time-lapse observation of dynamic events in living cells.



Photo activation of PA-GFP in a living mammalian cell by 405nm laser irradiation

Photos courtesy of: Tomoki Matsuda and Takeharu Nagai, Research Institute for Electronic Science, Hokkaido University



TIRF-photo activation

With the integration of the laser TIRF illuminator and photo-activation unit, both functions are now combined on one microscope. The user can switch between the two functions with ease.



TIRF-PAU illuminator unit



White light TIRF

This unit allows high-performance yet cost-effective total internal reflection fluorescence microscopy as well as oblique and standard widefield fluorescence techniques using mercury illumination. The wide wavelength band of mercury illumination makes multiple wavelength TIRF observation possible by simply changing filter cubes.



Epi-fl illuminator unit with white light TIRF

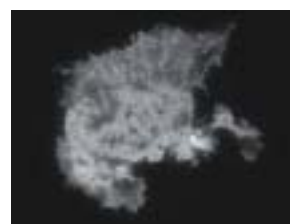

Photo courtesy of: Yasushi Okada, Cell Biology, Graduate School Medical Department, The University of Tokyo

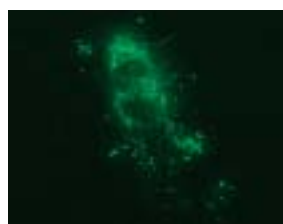

Photo courtesy of: Richard Cheney Ph.D., UNC Chapel Hill

Epi-fluorescence

Chromatic aberration has been significantly improved over a broad wavelength range to provide sharper and brighter fluorescence images.



Epi-fl illuminator unit



FRET

For analysis of intracellular Ca²⁺ concentration

Using FRET (Förster Resonance Energy Transfer) technique, intermolecular interactions between molecules within close proximity of one another can be detected and measured. Using the optional back port, each FRET channel can be separated by wavelength and sent to separate cameras simultaneously. This enables the capture of high-resolution images in the entire frame for each wavelength. Even when intensity difference between wavelengths is large, a high-quality FRET image can be captured by adjusting camera sensitivity for each wavelength.

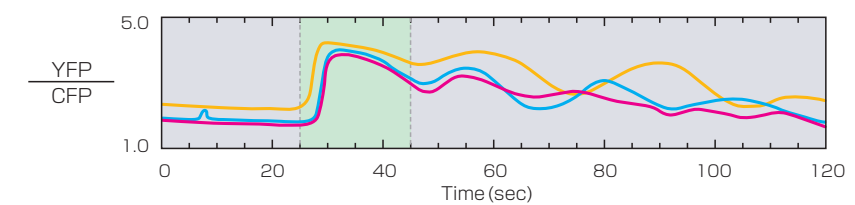
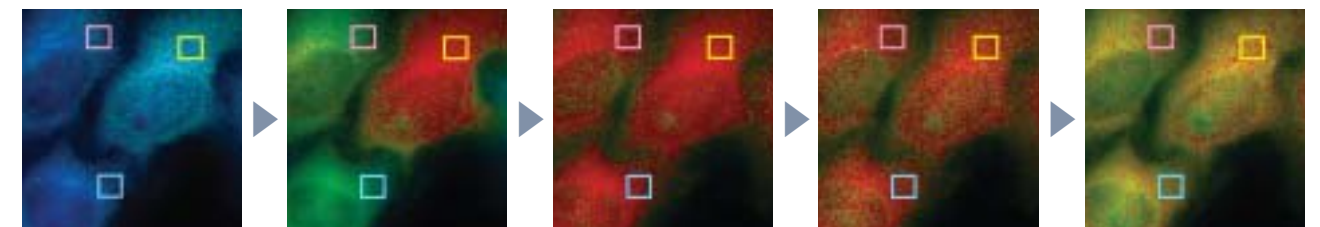

Imaging histamine-evoked Ca²⁺ release in mammalian cells reported by a FRET-based Ca²⁺ indicator, YC3.60
Photos courtesy of: Kenta Saito and Takeharu Nagai, Research Institute for Electronic Science, Hokkaido University

Ti: Excellent Imaging

Use of Optimal Optical Technology for Each Observation Method Allows Uncompromised Image Capture

Nikon's uncompromising optical technologies provide diverse multi-modal visual information of a specimen using any observation method, delivering the full range of cellular details to researchers.



Ti: High Performance with User-Friendly Operation

Enhanced Operability Enables Comfortable Observation

All buttons and control switches for motorized operation are designed considering ease of operation, visibility and understandability. Users can concentrate on their research without being hindered by microscope operations.



Nikon Advanced Modulation Contrast

Nikon has developed dedicated objectives for advanced modulation contrast. Colorless and transparent samples can be observed in high relief with a plastic dish, which is not possible in DIC observation. The direction of contrast can be matched to S Plan Fluor ELWD NAMC objectives, thereby allowing optimal contrast selection for techniques like microinjection and ICSI.



Photos courtesy of: Gianpiero D. Palermo, M.D., Ph.D., Cornell University

Nomarski DIC

The perfect balance of high contrast and high resolution is imperative for the observation of smaller structures. Nikon's unique DIC system is designed to achieve uniform high-resolution images even at low magnifications. The new DIC sliders (dry types) include high-resolution and high-contrast choices.

Motorized analyzer cube

A filter cube style DIC analyzer can be mounted on the motorized filter turret to minimize switching time between DIC observation and fluorescence observation.



Filter cube style DIC analyzer

Darkfield

Use of high NA condenser allows darkfield observation. Long-term observation of nanoparticles without photobleaching is possible.



Photo courtesy of: Jan Liphardt, University of California Berkeley

Highly parallel single-molecule DNA bending assay using darkfield microscopy. Each bright green spot is a single plasmon ruler, composed of a pair of DNA-linked gold nanoparticles. Enzymatic DNA bending or cleavage can be monitored by following the intensity and color of the plasmon rulers. For more information see Reinhard et al, PNAS (2007).

Phase contrast

For critical phase contrast observation, the CFI Plan Fluor ADH 100x (Oil) objective is available. This objective reduces halos and doubles the contrast of minute cell detail compared to conventional phase contrast objectives. It enables phase contrast observation of specimens with low-contrast minute structures within the cell.



CFI Plan Fluor ADH 100x (Oil) objective

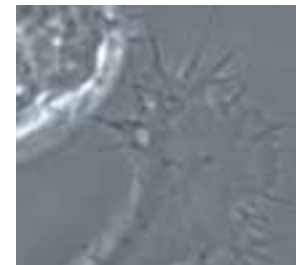

Viewed with an ADH objective

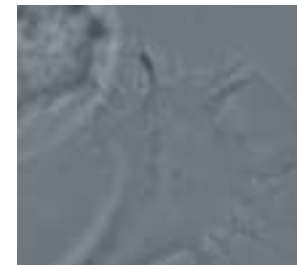

Viewed with a conventional phase contrast objective

Fast and comfortable operation with motorized components

Operation buttons on both sides of microscope body

Fluorescence filter changeover, objective changeover, objective retraction, Z-axis coarse/fine changeover, PFS on/off control and offset storage, diascope illumination on/off control can be operated quickly with easy-to-identify buttons on the microscope body.



High-speed position changing of the filter cubes in 0.25 second

Newly developed joystick and ergonomic controllers

High-speed motorized XY stage and Z-axis can be controlled using the joystick or ergo controller units. The joystick also allows a custom programmed speed adjustment with precise and natural operational feel.



Joystick unit



Ergonomic controller

Joystick and ergonomic controllers can not be used simultaneously; they are offered to provide a personal choice of control.

VFD screen and operation buttons on front of microscope body

Microscope status including attached objective information and on/off condition of the PFS can be confirmed on the display at a glance.



Visual confirmation of the buttons can be clearly viewed in the dark

PFS offset dial

The PFS offset is within easy reach to facilitate control. Coarse/fine switching is possible with simple button operation.



PFS offset dial

Remote controller touch panel and preset buttons

The microscope can be operated and microscope status is confirmed with icons. Also, observation conditions can be memorized with preset buttons. This enables switching observations from phase contrast to fluorescence with a single touch of a button, allowing the user to concentrate on observation without stress or averting attention from the task.



Remote controller

Sophisticated original slant design

By inclining the front part of the microscope's body slightly backward the distance between the operator's eyepoint and the specimen has been reduced by about 40mm, improving visibility and ergonomic design.

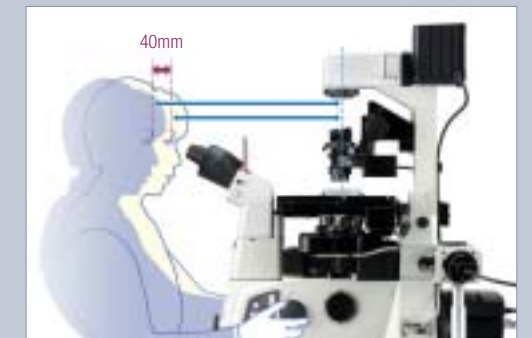

Fast, automatic operation by integrated control with NIS-Elements software

Microscopes have evolved from merely observation devices to software-controlled data acquisition devices. Nikon's Ti series not only features fast and comfortable motorized operation, but it also realizes acquisition of reliable data by controlling all motorized components for automatic imaging with the NIS-Elements imaging software.

● Nikon motorized XY stage



Fast and precise positioning is possible. Suitable for multipoint time-lapse observation. (Available as encoded or non-encoded versions)

● Piezo Z stage



High-speed, precise Z-axis control is possible. (Manufactured by Mad City Labs, Inc.)

● Motorized nosepiece



Six objective positions can be changed. (Photo shows motorized PFS nosepiece)

● Motorized filter rotating turret



Position of fluorescence filter cubes can be changed in 0.3 sec. per position. (Photo shows high-performance type)

● Motorized condenser turret



Motorized condenser changeover is possible.

● Motorized barrier filter wheel



Fluorescence barrier filter positions (8 positions—using 25mm filters) can be changed at a high speed of 0.15 sec. per position.

■ Ti-E can be fully motorized with the HUB-A

Communication speed is dramatically increased through proprietary motorization algorithms, innovatively accelerating the sequence of operation. The Ti-E assures more reliable and efficient data acquisition in the research field.



HUB-A

■ Four components of Ti-U/S can be motorized with the HUB-B

By attaching HUB-B unit to the Ti-U/S, two optional motorized components, such as fluorescence filter turret and condenser turret, in addition to the stage and nosepiece, can be motorized, greatly enhancing flexibility.



HUB-B



● Remote controller



Microscope status can be confirmed with icons. The microscope can be operated via the touch panel.

● PFS offset dial



Real-time offset amount of Z-axis depth can be controlled after PFS setting.

● Joystick unit



Flexible positioning of the motorized stage is possible.

● Ergonomic controller



Multiple operations are possible with manual controller.

● Motorized laser TIRF illumination unit



Motorized control of laser incident angle and repositioning by memory settings are possible.

● Motorized shutter "Smart shutter"



High-speed shutter for fluorescence excitation and brightfield illumination (Manufactured by Sutter Instrument Company)

● Motorized HG precentered fiber illuminator "Intensilight"



Controls shutter on/off and intensity of fluorescence excitation light.

● Motorized excitation filter wheel



Fluorescence excitation filters (8 positions—using 25mm filters) can be changed at a high speed of 0.15 sec. per position.

Compact, High-Performance CCD Cameras

Digital Sight series digital cameras for microscopes

These camera systems allow for smooth integration with a microscope and other products. Different combinations of camera head and control unit meet the requirements for any microscopic image acquisition.



Camera heads



DS-Qi1
Definitive camera for fluorescence time-lapse imaging features high sensitivity, low noise, superior quantitative linear response and quantum efficiency, wide dynamic range and high frame rate.



DS-Vi1 NEW
High-speed 2.0-megapixel color camera head displays smooth, high-quality live images.



DS-Ri1
Ultra-high-resolution 12.7-megapixel, 2200TV line cooled color camera that provides faithful reproduction of specimen color and fast display of live images. A Peltier cooling mechanism reduces heat noise.



DS-Fi1c
High-definition 5.0-megapixel cooled color camera head. Cooling mechanism retains CCD at room temperature minus 20°C and realizes low noise.



DS-Fi1
High-definition 5.0-megapixel color camera head features high frame rate, high red sensitivity, high resolution and accurate color reproduction.

Control units

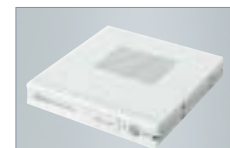

DS-U2
USB2.0 PC-use control unit is suitable for operations from advanced image capture to image processing and analysis by integrating control of camera, peripherals and microscope with NIS-Elements imaging software.



DS-L2
Standalone control unit with high-resolution large 8.4-in. LCD monitor allows image capture without a PC. Pre-programmed imaging modes realize optimal imaging settings by choosing icons of the illumination method. Annotation, calibration and measurement tools are provided. Various digital interfaces and networking function enable images to be shared. Various USB 2.0 media storage, HUB and host control are provided.

Comprehensive Imaging & Analysis Software

Imaging software NIS-Elements

NIS-Elements has been developed by Nikon, a leader in microscope and camera technology. It allows automated operations from advanced image acquisition to analysis and measurement by integrating control of microscope, camera and peripherals. It is Nikon's modular imaging software ideally integrated for all microscopy applications.

6D/4D packages selectable depending on purpose

Ar (advanced research) package that allows image acquisition up to 6D (X, Y, Z, time, Lambda (wavelength), multipoint) and analysis and Br (basic research) package that allows up to 4D image acquisition are available depending on research purposes and specimens. Upgrades are also possible by adding diverse optional modules.

NIS-Elements D, designed for easy image acquisition yet powerful and economical, is also available.

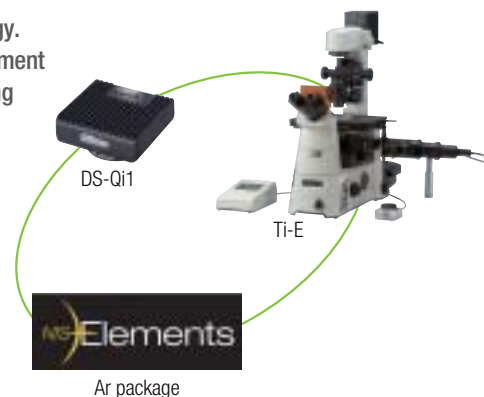

Advanced Confocal Laser Scanning Microscopes

Advanced confocal laser microscopes optimally match the Ti-E

Confocal microscope

A1R/A1

The A1R with a revolutionary hybrid scanner realizes ultrafast and high-resolution imaging

- Hybrid scanner capable of high-speed imaging at 420 fps (512 x 32 pixels) allows simultaneous imaging and photo activation (A1R)
- High-resolution imaging up to 4096 x 4096 pixels
- With the VAAS pinhole unit, flare can be eliminated and image brightness retained; different sectioning can be simulated after image acquisition
- Dichroic mirror with 30% increased fluorescence efficiency provides high image quality

Multiphoton confocal microscope

A1R-MP

High-speed imaging of deep area in a living specimen

- Resonant scanner enables imaging up to 420 fps (512 x 32 pixels)
- Deep imaging with high-sensitivity NDD (non-descanned detector)
- Sharper, brighter imaging with high NA objectives deposited with Nano Crystal Coat
- High-speed, high-precision unmixing with NDD
- Multiphoton laser beam can be automatically aligned with a single click

True spectral imaging confocal microscope

A1Rsi/A1si

High-performance spectral detector supports simultaneous excitation of multiple wavelengths

- Acquisition of 32 channels (512 x 32 pixels) at 24 fps in a single scan
- Accurate, real-time spectral unmixing
- Simultaneous excitation of four lasers
- V-filtering function adjusts individual sensitivity of up to four spectral ranges, allowing production of customized filters that are optimal for various fluorescence probes



A1Rsi/A1si

High-speed imaging during photo activation

While imaging a HeLa cell expressing Kaede with green and red fluorescence using 488nm and 561nm lasers as excitation lights, Kaede in a ROI is continuously activated with the 405nm laser for photo conversion. The dispersion of Kaede red fluorescence produced by photo conversion can be observed.

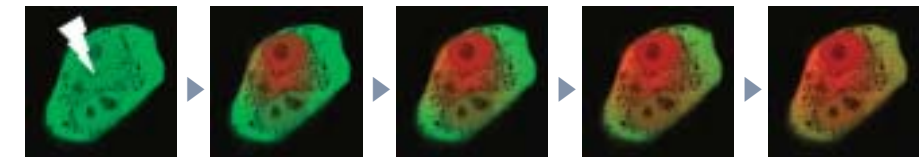

Activation laser wavelength: 405nm, Imaging laser wavelength: 488nm/561nm, Image size: 512 x 512 pixels, 1 fps
Photos courtesy of: Dr. Tomoki Matsuda and Prof. Takeharu Nagai, Research Institute for Electronic Science, Hokkaido University

Confocal microscope

C1 plus

Personal confocal microscope now supports FRAP

- 1000x optical zoom of ROI
- ROI scanning is possible with an optional AOM/AOTF
- Accommodates a greater variety of lasers with wavelengths ranging from 405 to 640nm
- 4-channel simultaneous acquisition such as 3-channel confocal plus DIC

True spectral imaging confocal microscope

C1si

Spectra across a wide 320nm range captured with a single scan

- High-speed, low-invasive imaging by a single scan acquisition
- Unmixing of spectral images without crosstalk
- Nikon's proprietary DEES and DISP technology for bright images
- Accuracy of spectra is maintained with diverse correction technologies

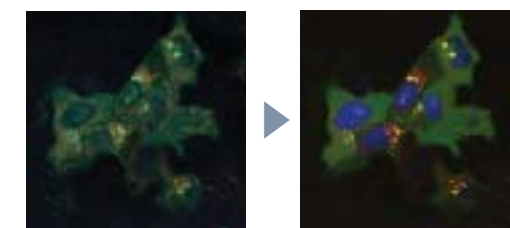
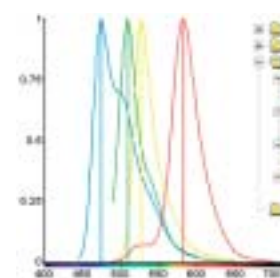

HeLa cell in which nucleus is labeled with CFP, actin-related protein (Fascin) labeled with GFP, Golgi body labeled with YFP, and mitochondria labeled with DsRed. Spectral image captured with 408nm and 488nm laser exposure (left). The fluorescence spectra of the captured image are unmixed using reference spectra (right).

Photos courtesy of: Kaoru Katoh and Ayako Kojima, Neuroscience Research Institute, The National Institute of Advanced Industrial Science and Technology (AIST)

Accessories

● Incubator

The internal temperature of the case is maintained at 37°C. However, temperature adjustment from room temperature to 50°C is possible. The incubator is compatible with both the rectangular stage and the motorized stage. Various dishes can be used, including a well plate, with different inside attachments.



● Thermal plate warmer ThermoPlate MATS series

A temperature controllable stage ring with a glass heating plate keeps the specimen at a set temperature. Temperature is adjustable from room temperature to 50°C in 0.1°C increments.

Manufactured by Tokai Hit Co., Ltd.



For motorized stage



● Stage incubation system INU series

It sustains the internal temperature at 37°C with humidity of 90% and CO₂ of 5% to keep the specimen in a stable and precise condition for about three days. A special technique is employed to minimize focus drift caused by thermal expansion of a stage. The glass heater on top of the chamber prevents condensation and enables clear images.

Manufactured by Tokai Hit Co., Ltd.



● NT-88-V3 micromanipulator system

A packaged set of compact instrumentation—about half the size of a conventional model—for cellular micromanipulation, the NT-88-V3 is ideal for IVF (in-vitro fertilization), ICSI (intracytoplasmic sperm injection), electrophysiology, or transgenic biotechnology applications. Hanging joystick design provides superior ergonomics and operability. Remote oil hydraulic operation minimizes pipette vibration. An index of the coarse manipulator enables easy position adjustment of the pipette.

Manufactured by Narishige Co., Ltd.



Ergonomic Eyepiece Tube



Eyepiece inclination is adjustable from 15° to 45°. Includes darkslide shutter and Bertrand lens.

Binocular Eyepiece Tube D



Observation of conoscopic image with incorporated Bertrand lens (phase telescope) is possible and darkslide shutter is provided.

Binocular Eyepiece Tube S



Standard model

Eyepiece Tube Base Unit/Phase Contrast



High-resolution imaging with "full intensity" external phase contrast system is possible. TV port is incorporated.

Eyepiece Tube Base Unit/Side Port



TV port is incorporated.

Plain Eyepiece Tube Base Unit



Standard model

Eye Level Riser



Two 25mm emission filters can be installed.

Stage Up Position Set



Stage height can be raised by 70mm to mount multiple components utilizing expanded stratum structure.

Stage Base



Stage base for configuration without diascope illumination

Back Port Unit



Combined use with stage up riser allows a camera to be mounted on a back port.

High NA Condenser (Oil/Dry)



Perfect for observation with high NA objectives

CLWD Condenser



For high NA long working distance objectives

NAMC Condenser



For observation of Nikon Advanced Modulation Contrast

Stage Ring



Acrylic ring (left) features superior objective lens visibility and the glass ring (right) features less thermal expansion—ideal for time-lapse observation.

Epi-fluorescence Attachments



Light source and illumination optics for high S/N images

Double Lamphouse Adapter



For attaching two light sources

System Diagram

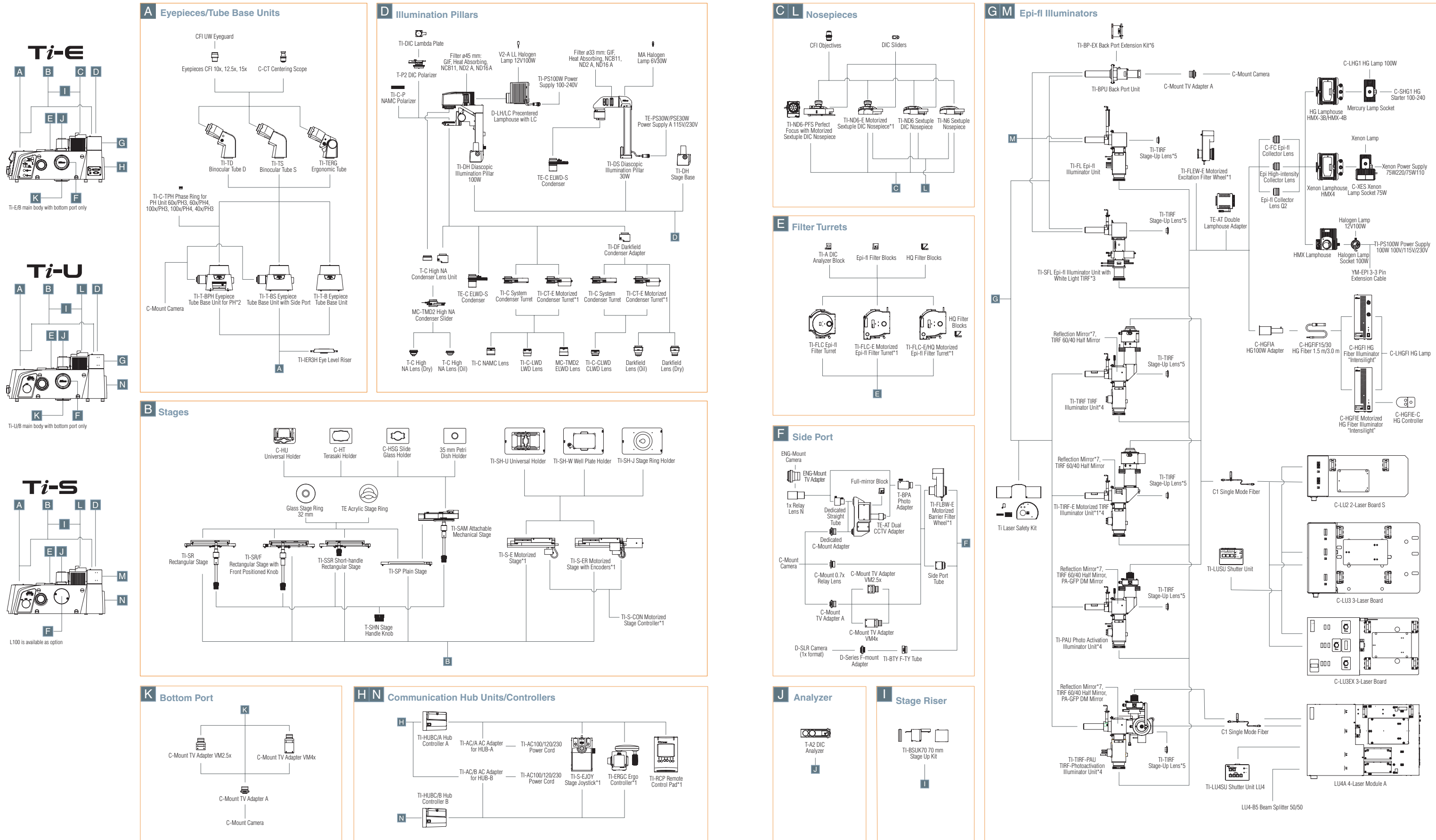

*1: Requires a Communication Hub Controller *2: Cannot be used with stage riser *3: Combination with C-HGFI/HGFI Fiber Illuminator "Intensilight" is not recommended *4: Cannot be attached to Ti-S
 *5: Necessary for incorporating an illuminator unit in lower tier of the stratum structure *6: Necessary for Back Port Unit when used with TIRF-Photoactivation Illuminator Unit *7: Included in the Illuminator Units

Specifications



Ti-E



Ti-U



Ti-S

		Ti-E, Ti-E/B	Ti-U, Ti-U/B	Ti-S, Ti-S/L100
Main body	Port	4 Ti-E: eyepiece 100%, left 100%, right 100%, eyepiece 20%/left 80% Ti-E/B: eyepiece 100%, left 100%, right 100%, bottom 100% Motorized port switching	4 Ti-U: eyepiece 100%, left 100%, right 100%, optional Ti-U/B: eyepiece 100%, left 100%, right 100%, bottom 100% Manual port switching	2 Ti-S: eyepiece 100%, eyepiece 20%/left 80% Ti-S/L100: eyepiece 100%, left* 100% Manual port switching *Changeable to right as option.
	Two ports (tube base unit with side port, back port) can be added optionally.			
	Focusing	Via motorized nosepiece up/down movement Stroke (motorized): up 7.5mm, down 2.5mm Motorized (pulse motor) Minimum step: 0.025µm Maximum speed: 2.5mm/sec or higher Motorized escape and refocus mechanism (coarse) Coarse/fine switchable	Via nosepiece up/down movement Stroke (manual): up 8mm, down 3mm Coarse stroke: 5.0mm/rotation Fine stroke: 0.1mm/rotation Minimum fine reading: 1µm	
			Coarse refocusing mechanism	—
	Intermediate magnification	1.5x		—
	Other	Light intensity control, Light on/off switch, VPD on front of body, Operation with controller		—
Eyepiece tube	Eyepiece tube body	TI-TD Binocular Tube D, TI-TS Binocular Tube S, TI-TERG Ergonomic Tube		
	Eyepiece tube base	TI-T-B Eyepiece Tube Base Unit, TI-T-BPH Eyepiece Tube Base Unit for PH, TI-T-BS Eyepiece Tube Base Unit with Side Port		
	Eyepiece lens	CFI 10x, 12.5x, 15x		
Illumination pillar		TI-DS Diascopic Illumination Pillar 30W, TI-DH Diascopic Illumination Pillar 100W		
Condenser		ELWD condenser, LWD condenser, NAMC condenser, ELWD-S condenser, High NA condenser, Darkfield condenser, CLWD condenser		
Nosepiece		TI-ND6-E Motorized Sextuple DIC Nosepiece, TI-N6 Sextuple Nosepiece, TI-ND6 Sextuple DIC Nosepiece, TI-ND6-PFS Perfect Focus with Motorized Sextuple DIC Nosepiece		
Objectives		CFI60 objectives		
Stage		TI-S-ER Motorized Stage with Encoders, TI-S-E Motorized Stage—Cross travel: X110 x Y75mm, Size: W400 x D300mm (except extrusions) TI-SR Rectangular Stage, TI-SR/F Rectangular Stage with front positioned knob, TI-SSR Short-handle Rectangular Stage—Cross travel: X70 x Y50mm, Size: W310 x D300mm TI-SP Plain Stage—Size: W260 x D300mm TI-SAM Attachable Mechanical Stage—Cross travel: X126 x Y84mm when used with TI-SP Plain Stage		
Motorized functions		Focusing, Port switching, Coarse focusing		—
Epi-fluorescence attachment		Sextuple fluorescence filter cube rotating turret, Filter cubes with noise terminator mechanism, Field diaphragm centerable, 33mm ND4/ND8 filters, 25mm heat absorbing filter Option: Motorized sextuple fluorescence filter cube rotating turret, Motorized excitation filter wheel, Motorized barrier filter wheel		
Nomarski DIC system		Contrast control: Senarmont method (by rotating polarizer) Objective side prism: for individual objectives (installed in nosepiece) Condenser side prism: LWD N1/N2/NR (Dry), HNA N2/NR (Dry/Oil) types		
Weight (approx.)		Phase contrast set: 41.5kg Epi-fl set: 45.4kg	Phase contrast set: 38.5kg Epi-fl set: 42.3kg	Phase contrast set: 29.6kg Epi-fl set: 33.4kg
Power consumption (max.)		Full set (with HUB-A and peripherals): approx. 95W		Full set (with HUB-B and peripherals): approx. 40W

Nikon's Inverted Microscope Legacy and the History of Discovery



Eclipse Ti-E



Eclipse TE300



Eclipse TE2000



Diaphot TMD



Diaphot 300



Model M



Model MSD

- 2007
 - **Eclipse Ti-E, the next generation of discoveries begins today**
 - PFS (perfect focus system)
 - Laser TIRF
 - Simplified DNA sequencing on the TE2000
- 2000
 - **Eclipse TE2000**
 - IR laser trapping
 - Special inverted model used in space
 - Cumulina the mouse cloned on the TE300
- 1996
 - **Eclipse TE300**
 - Breakthroughs: CFI 60 optics expanded infinity space
 - Dolly the sheep cloned on the Diaphot 300
 - First intracytoplasmic sperm injection (ICSI) on the Diaphot
- 1990
 - **Diaphot 300**
 - High NA DIC
 - Rectified DIC
 - Extra long working distance optics
 - The brightest fluorescence
 - World's first IVF baby on the Diaphot TMD
- 1980
 - **Diaphot TMD, a revolutionary market leader for inverted microscopy**
 - Beginning of FURA/CA⁺ 340nm imaging
- 1976
 - First CF optics
 - First Hoffman Modulation Contrast[®]
- 1966
 - **Model MSD, the first affordable tissue culture microscope**
- 1964
 - **Model M, the legacy begins**
 - Pioneering 16mm time-lapse live cells

● Landmark achievements for Nikon
 ● Nikon's unique technical innovations in inverted microscopy
 ● Key scientific breakthroughs and Nikon's participation in some of these

Dimensional Diagram

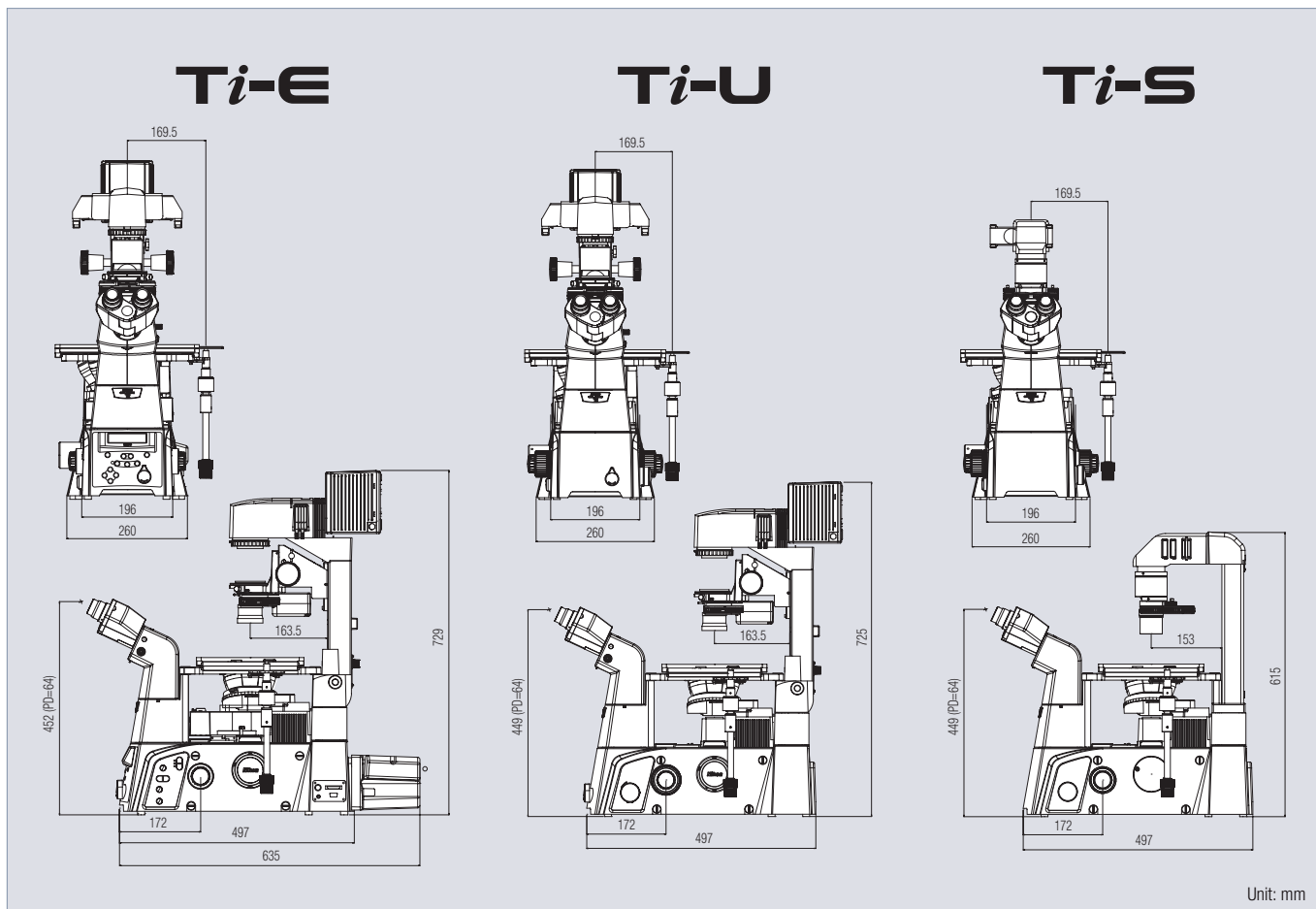

Enter the "Microscopy University" on the web and discover a whole new world. www.microscopyu.com

Specifications and equipment are subject to change without any notice or obligation on the part of the manufacturer. March 2010 © 2007-10 NIKON CORPORATION

WARNING TO ENSURE CORRECT USAGE, READ THE CORRESPONDING MANUALS CAREFULLY BEFORE USING YOUR EQUIPMENT.

Monitor images are simulated. Company names and product names appearing in this brochure are their registered trademarks or trademarks.

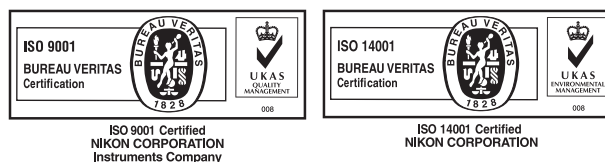

NIKON CORPORATION
Shin-Yurakucho Bldg., 12-1, Yurakucho 1-chome, Chiyoda-ku, Tokyo 100-8331, Japan
phone: +81-3-3216-2375 fax: +81-3-3216-2385
<http://www.nikon.com/instruments/>

NIKON INSTRUMENTS INC.
1300 Walt Whitman Road, Melville, N.Y. 11747-3064, U.S.A.
phone: +1-631-547-8500; +1-800-52-NIKON (within the U.S.A. only)
fax: +1-631-547-0306
<http://www.nikoninstruments.com/>

NIKON INSTRUMENTS EUROPE B.V.
Laan van Kronenburg 2, 1183 AS Amstelveen, The Netherlands
phone: +31-20-44-96-300 fax: +31-20-44-96-298
<http://www.nikoninstruments.eu/>

NIKON INSTRUMENTS (SHANGHAI) CO., LTD.
CHINA phone: +86-21-5836-0050 fax: +86-21-5836-0030
(Beijing branch) phone: +86-10-5869-2255 fax: +86-10-5869-2277
(Guangzhou branch) phone: +86-20-3882-0552 fax: +86-20-3882-0580

Nikon promotes the use of eco-glass that is free of toxic materials such as lead and arsenic.

Printed in Japan (1003-05)T

NIKON SINGAPORE PTE LTD
SINGAPORE phone: +65-6559-3618 fax: +65-6559-3668

NIKON MALAYSIA SDN. BHD.
MALAYSIA phone: +60-3-7809-3688 fax: +60-3-7809-3633

NIKON INSTRUMENTS KOREA CO., LTD.
KOREA phone: +82-2-2186-8410 fax: +82-2-555-4415

NIKON CANADA INC.
CANADA phone: +1-905-602-9676 fax: +1-905-602-9953

NIKON FRANCE S.A.S.
FRANCE phone: +33-1-4516-45-16 fax: +33-1-4516-45-55

NIKON GMBH
GERMANY phone: +49-211-941-42-20 fax: +49-211-941-43-22

NIKON INSTRUMENTS S.p.A.
ITALY phone: +39-055-300-96-01 fax: +39-055-30-09-93

NIKON AG
SWITZERLAND phone: +41-43-277-28-67 fax: +41-43-277-28-61

NIKON UK LTD.
UNITED KINGDOM phone: +44-208-247-1717 fax: +44-208-541-4584

NIKON GMBH AUSTRIA
AUSTRIA phone: +43-1-972-6111-00 fax: +43-1-972-6111-40

NIKON BELUX
BELGIUM phone: +32-2-705-56-65 fax: +32-2-726-66-45

Code No. 2CE-MQEJ-7

This brochure is printed on recycled paper made from 40% used material.

En